

P9

DGP A1

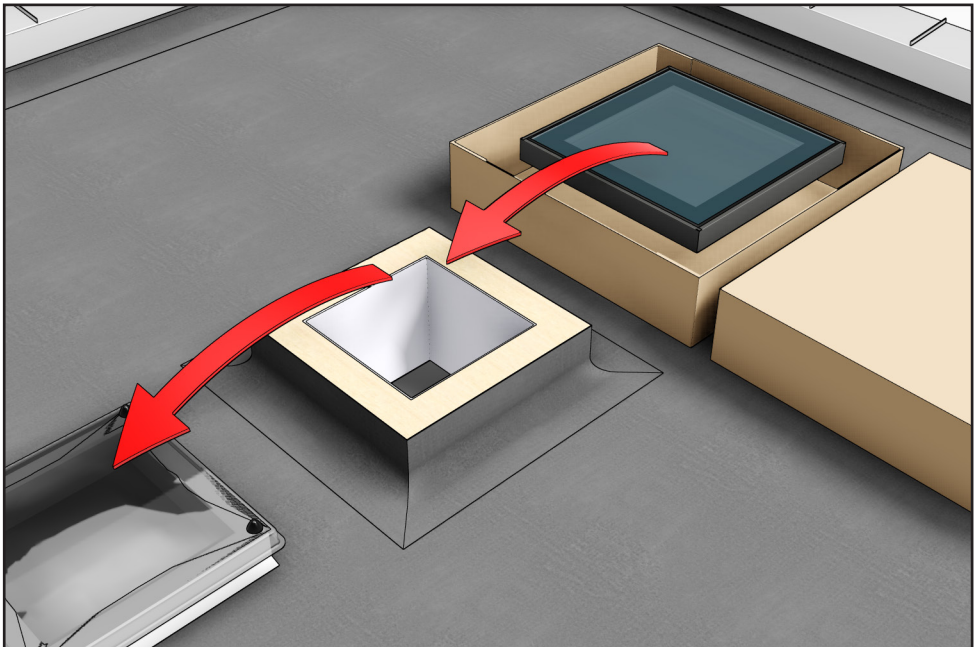

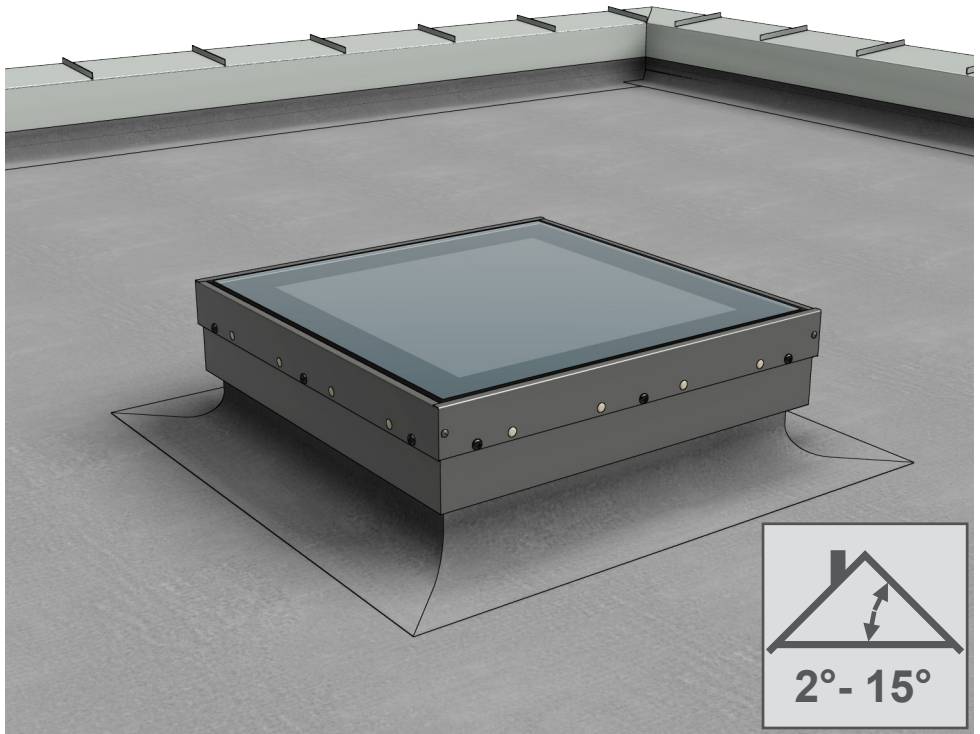

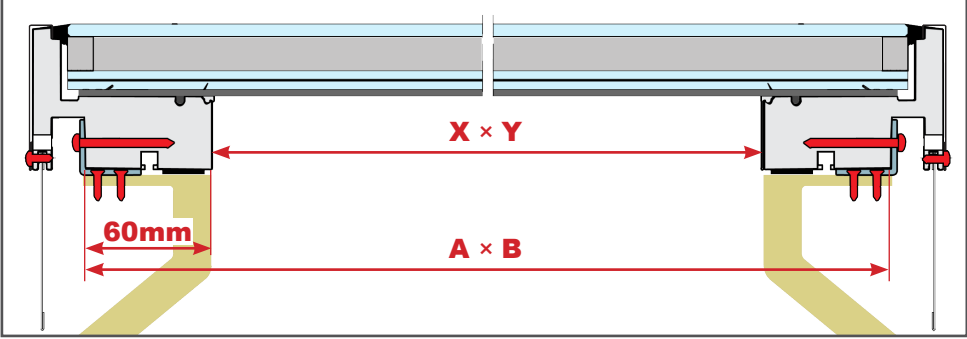
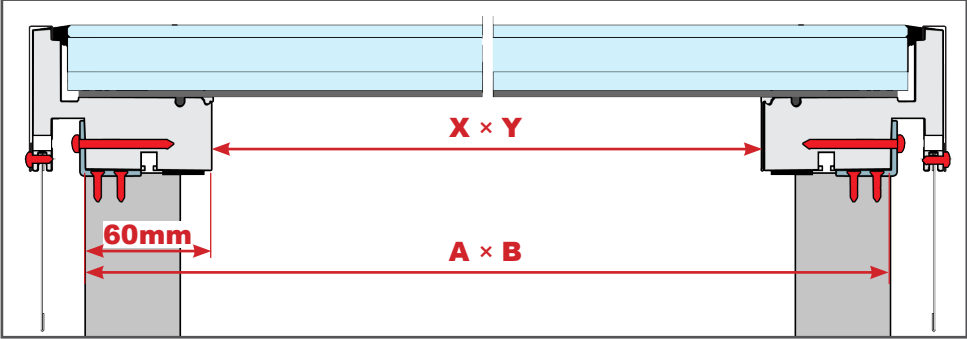
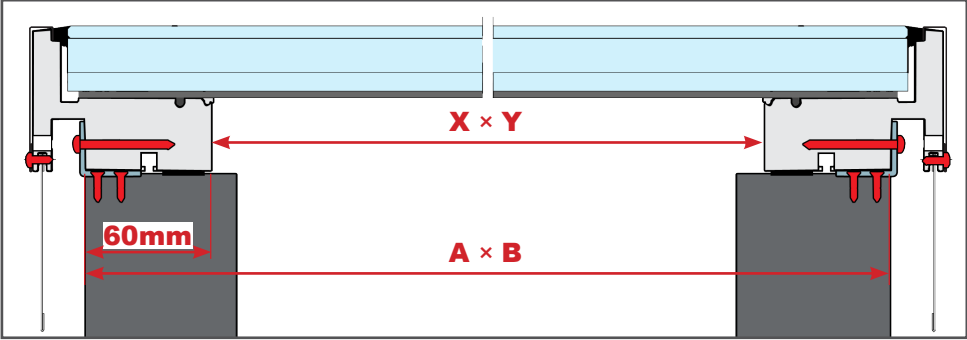
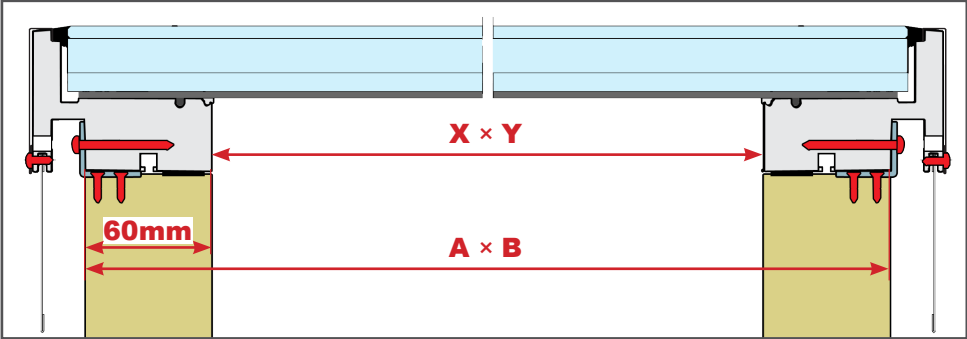
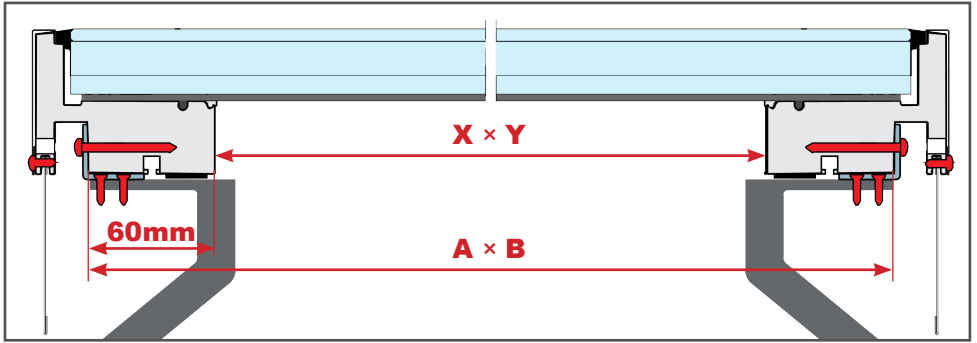

DGP A1	$X \times Y$ [mm]	A [mm]	B [mm]
60x60	600x600	720	720
60x90	600x900	720	1020
70x70	700x700	820	820
70x100	700x1000	820	1120
70x130	700x1300	820	1420
80x80	800x800	920	920
80x120	800x1200	920	1320
80x130	800x1300	920	1420
80x180	800x1800	920	1920
90x90	900x900	1020	1020
90x120	900x1200	1020	1320
100x100	1000x1000	1120	1120
100x130	1000x1300	1120	1420
100x150	1000x1500	1120	1620
100x200	1000x2000	1120	2120
110x110	1100x1100	1220	1220

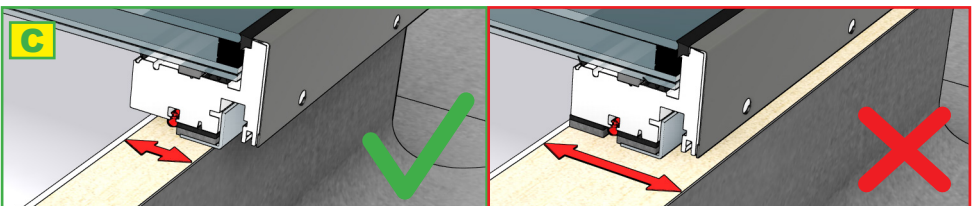
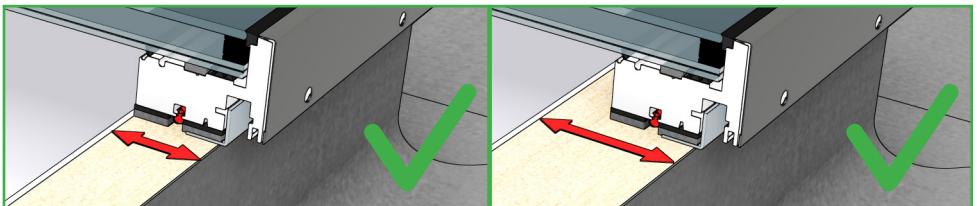

1

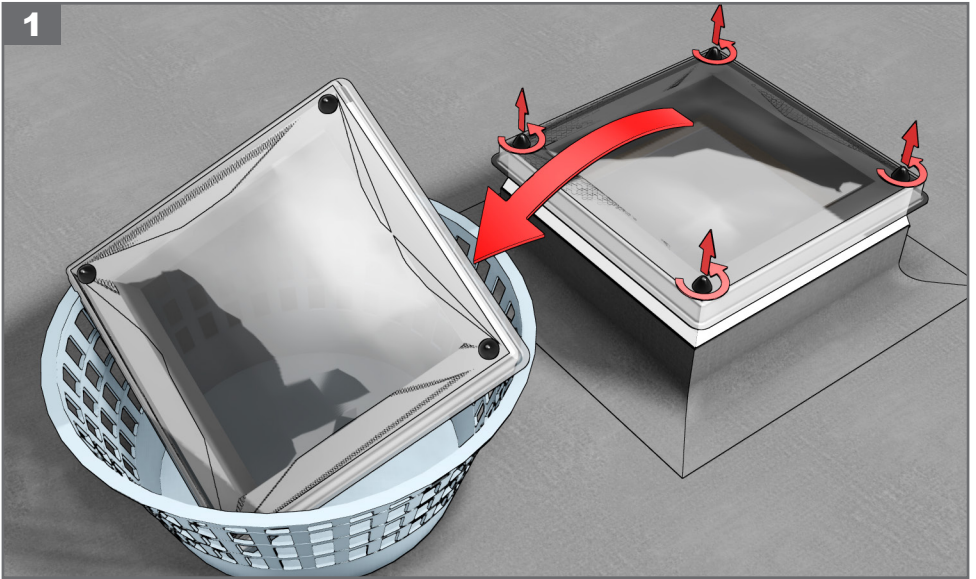

2

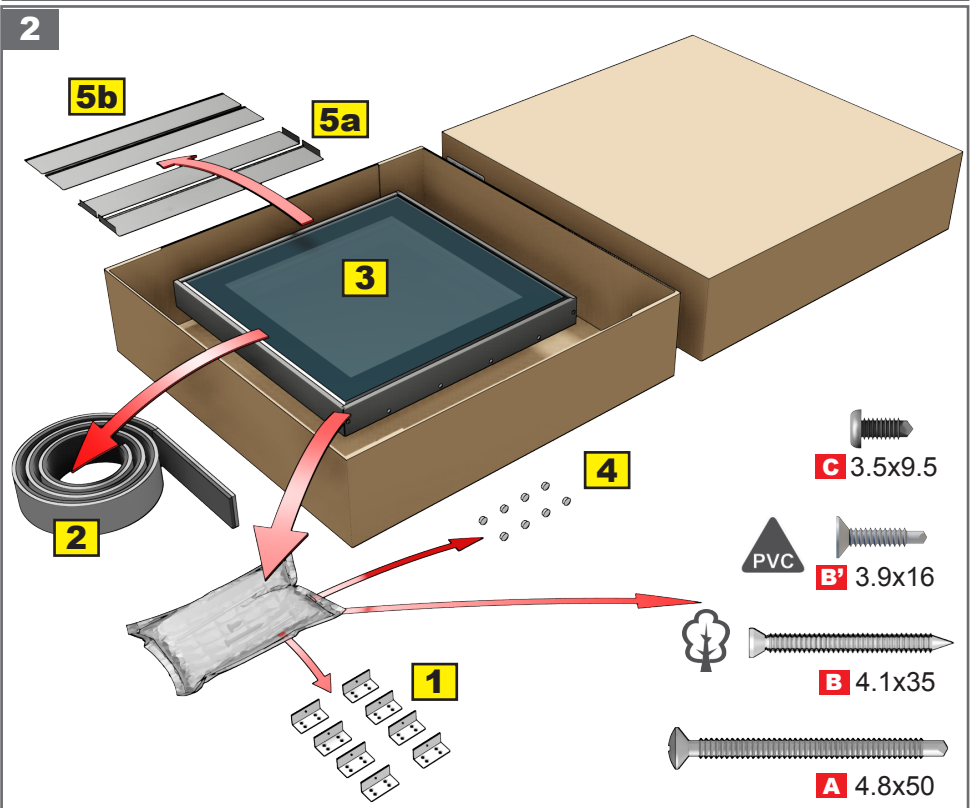

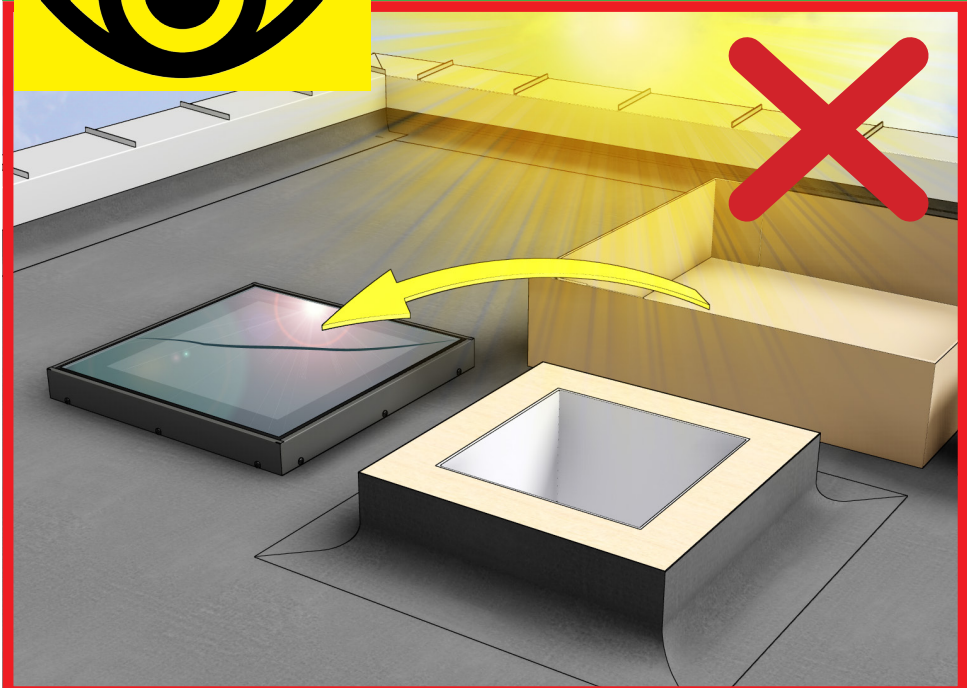
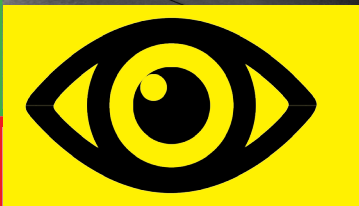
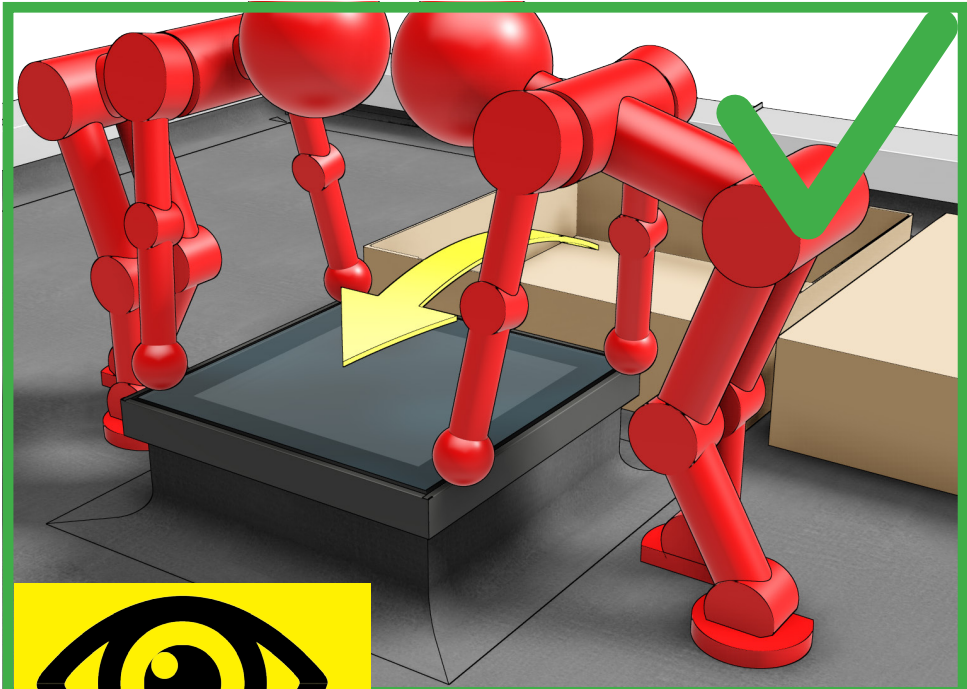

3

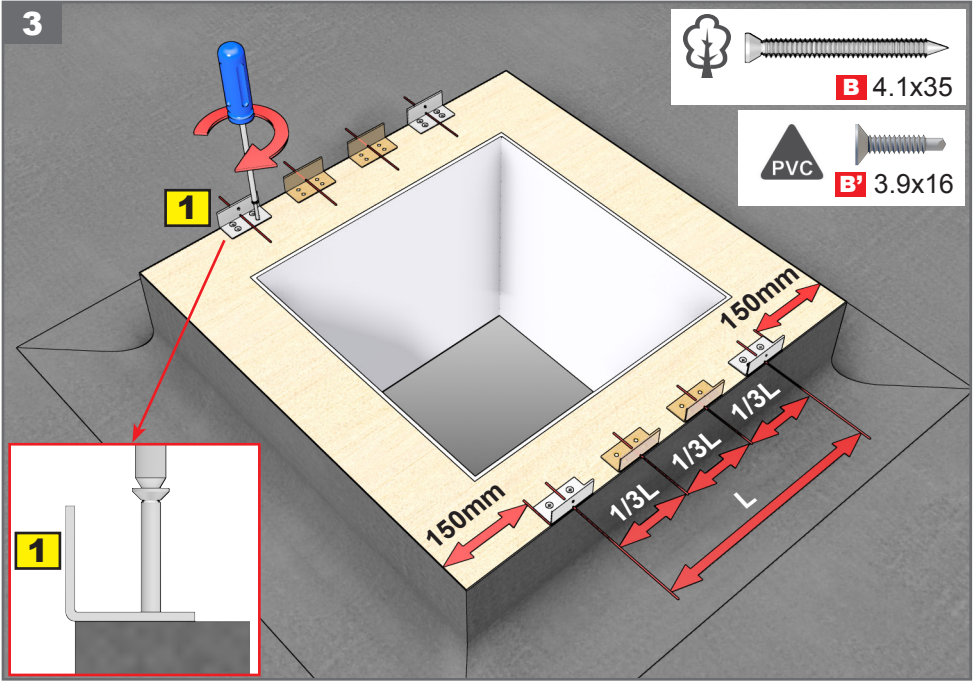

4

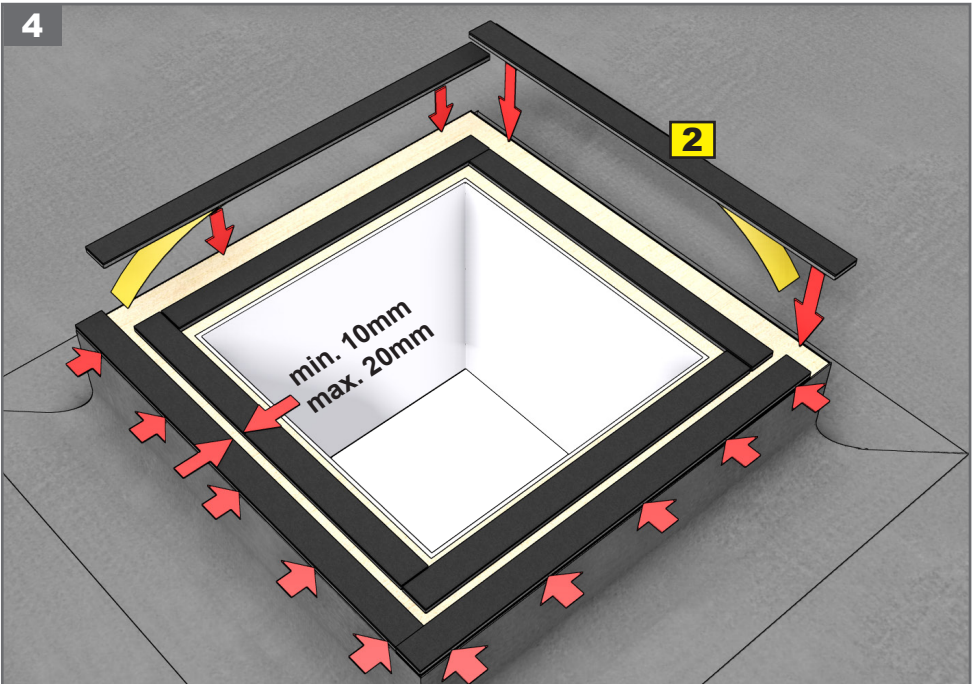

5

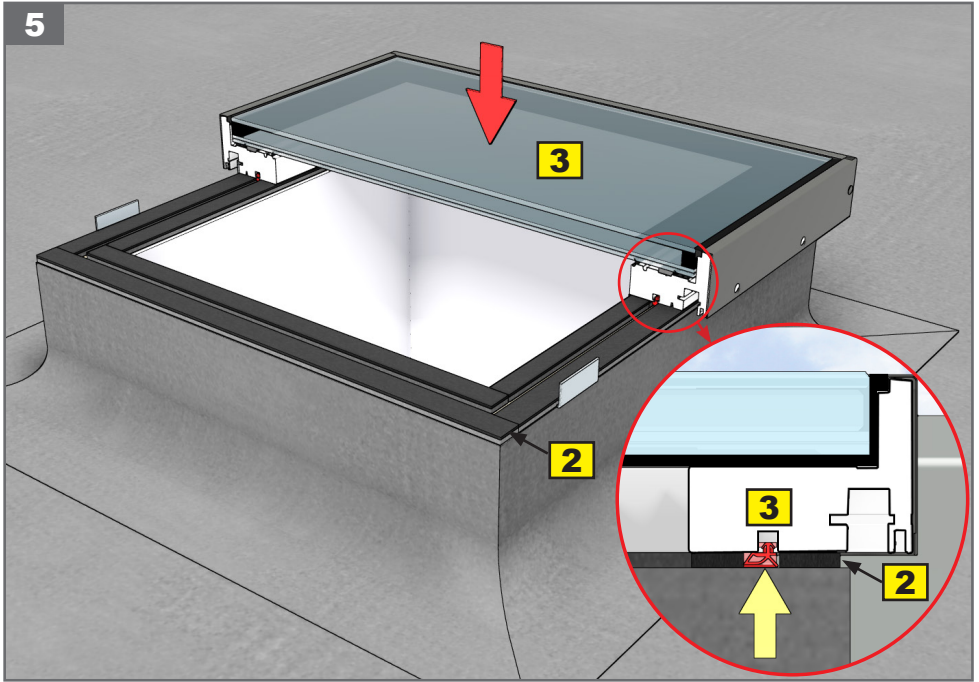

6

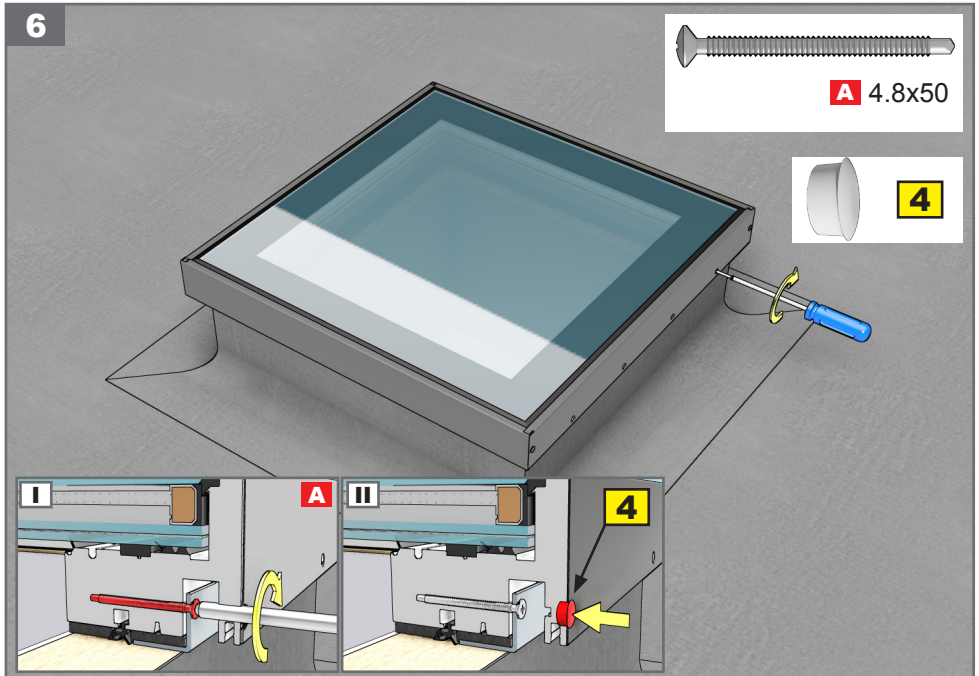

7

7

